



FARMFLEX® WHEELS
PRODUCT CATALOG 2019

AGRONOMIC WHEELS

THE EXPERIENCE OF **THE LEADER**
SINCE 1971





INDEX

<i>PAGE 3</i>	<i>OTICO</i>
<i>PAGE 4-5</i>	<i>PHILOSOPHY</i>
<i>PAGE 6</i>	<i>USES</i>
<i>PAGE 7</i>	<i>FARMFLEX® CONCEPT</i>
<i>PAGE 11</i>	<i>CHOOSE YOUR PROFIL</i>
<i>PAGE 12</i>	<i>FARMFLEX® WHEELS RANGE 2019</i>
<i>PAGE 29</i>	<i>FARMERS' TESTIMONIALS</i>

DESIGNING, MANUFACTURING AND SELLING ROLLING, SELF-CLEANING AGRONOMIC SOLUTIONS SINCE 1971, FOR FARMING EQUIPMENT THE WORLD OVER!

OTICO PRODUCT RANGE

FARMFLEX® Wheels



FARMFLEX® Rollers



TYRES & WHEELS
Inflatable tires



LOCATION



CHALMAISON
FACTORY
(FRANCE)



Ideally located an hour drive South-East of **Paris** in the heart of cereal crops country, the Chalmaison factory employs 150 people for **the design and manufacture** of the **FARMFLEX®** technology

product range. This site also hosts our **R&D centre** and our **laboratory**, thus streamlining new products development. Our location enables easy prototype-testing in the field via local partner-farmers.

PHILOSOPHY

EXPERIENCED



- ▶ Serving the farming community since **1971**.
- ▶ **48 years of experience** and a world-renowned craftsmanship.
- ▶ Manufacturing in our own factory **1 hours away from Paris**.
- ▶ A **modern, high-performing** industrial process.

- ▶ **Factory, headquarters and engineering department** share the same location in France.
- ▶ Raw materials are exclusively sourced within Europe to ensure **quality control and fast delivery**.



PROACTIVE

- ▶ A **high-capability, flexible Smart Factory** produces and ships worldwide.
- ▶ **719 000 FARMFLEX® tires and wheels** produced in 2017.
- ▶ **70-80 tons of rubber processed** each week.
- ▶ Weekly output : **15 000 wheels and 120-150 rollers**.

HIGH PERFORMANCE INDUSTRIAL TOOLS



- ▶ A **world-renowned** know-how.
- ▶ Present on all **5 continents**, through our partnership with machine manufacturers, distributors and dealerships.
- ▶ Frequent, **worldwide** deliveries using Air and Ground cargo.



WORLD-RENOWNED

RESEARCH & INNOVATION



- ▶ **45 international patents** filed.
- ▶ Internal product development thanks to an R&D team of **rubber and agricultural engineers**.
- ▶ An **engineering department and laboratory** focused on developing new products and new technologies.

- ▶ OTICO develops **premium rubber formulations** to fulfill **agronomic needs of all climates and continents**.
- ▶ Rigorous raw **materials testing**.
- ▶ **Extensive benchmark + in-field testing and quality control** for each new product.
- ▶ Production **control and traceability**.

UNPARALLELED QUALITY



TECHNICAL AND AGRONOMIC EXPERTISE



- ▶ **Terrain configuration study**.
- ▶ **Technical, functional and agronomic brief**.
- ▶ Constant liaison with “pilot” **partner-farmers**.

- ▶ Developing new types of **partnerships** with agricultural machinery manufacturers.
- ▶ White label, **exclusive production**.
- ▶ OTICO collaborates **confidentially** from the earliest stage of a new product development.
- ▶ **A wealth of experience** acquired on all 5 continents is made available to our clients.

OTICO X EQUIPMENT MANUFACTURERS PARTNERSHIPS



USES

“ FARMFLEX® WHEELS BY OTICO

SPECIFICALLY DESIGNED FOR INTENSIVE AGRICULTURAL USES!

PRECISION SEEDER



CONVENTIONAL SEED DRILL



DIRECT SEEDER



AIRSEEDER



GARDENING SEEDER



TRANSPLANTERS



SLURRY INJECTOR

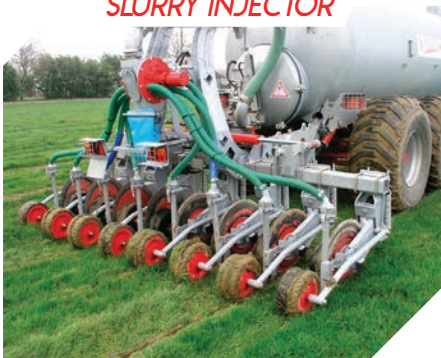

INTER-ROW CULTIVATORS



STRIP-TILL



**FOR ANY TYPE OF SOIL
AND FARMING PROCESS!**

FARMFLEX[®] CONCEPT

“SELF CLEANING BY CONCEPT

SEMI-PNEUMATIC, RELIABLE BY DESIGN

- ▶ Tire designed inside and out to be completely self-cleaning, using natural rubber elasticity
- ▶ Maintenance-free : no more punctures !

VERSATILITY

- ▶ Large range of tires available in various shapes and hardness depending on weather, soil, and farming process (conventional, minimum tillage, direct seeding)

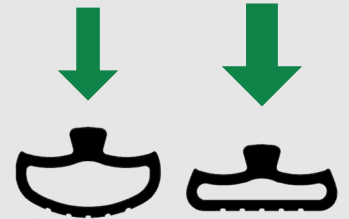

AGRONOMIC FUNCTIONS

PRECISE AND LOCALIZED SEED INCORPORATION

- ▶ Optimal soil/seed contact ensures even growth
- ▶ Water comes up by capillarity
- ▶ Precise and localized seed incorporation thanks to the inner and outer tire profile

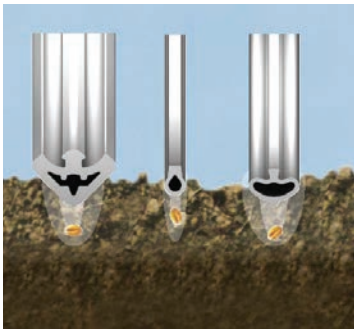

CLEANING OF THE SOWING DISCS

- ▶ LV wheel type scrapes and cleans the discs thanks to the outside lip



ACCURATE DEPTH CONTROL

- ▶ Seeding and tillage



FURROW CLOSING

- ▶ Soil is brought back on top of the seed



POLYMER WHEELS

POLYMER STEEL WHEELS

PB

Polymer closed flanges, bolted



PBB

Polymer radial flanges bolted



MPB

Metal / polymer, bolted



STEEL WHEELS

MB

Metallic, bolted



MBE

Metal, polymer, with polymer spacer



MM

Metallic, welded



MBB

Metallic radial flanges bolted



MBBE

Metallic radial flanges bolted with spacer



A

Single-row ball bearing(s)

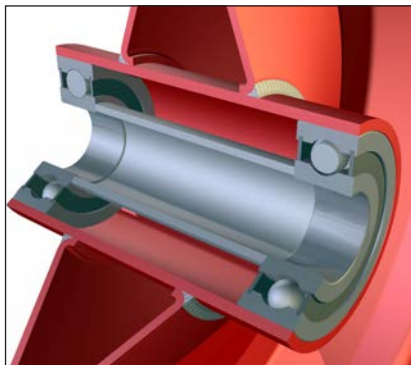

B

Two nylon rings

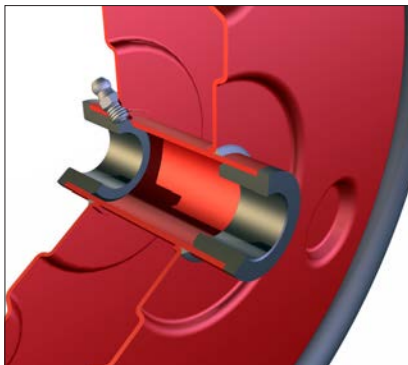

D

Two single-row ball bearings with cup

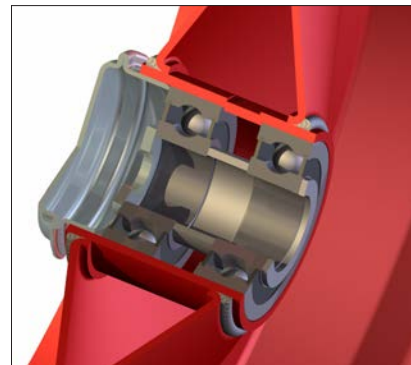

C1

Monobloc dual row ball bearing, protruding axle

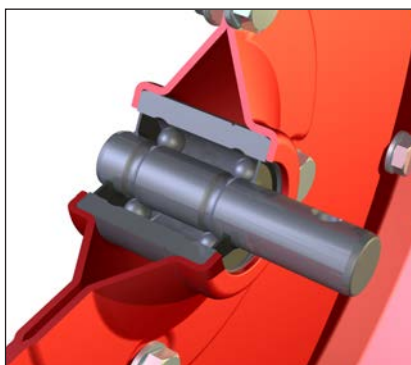

C2

Monobloc dual row ball bearing

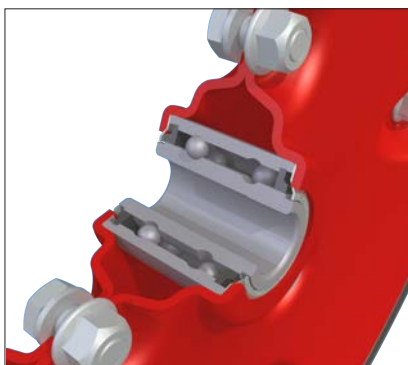

C2HD

Heavy Duty C2 hub

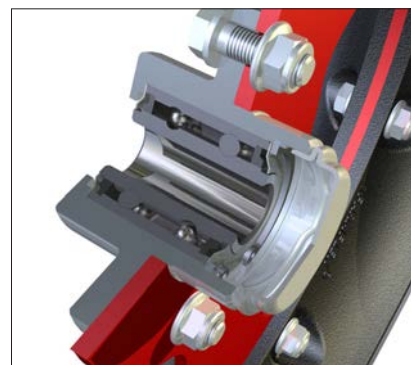

E

Needle bearing and nylon rings

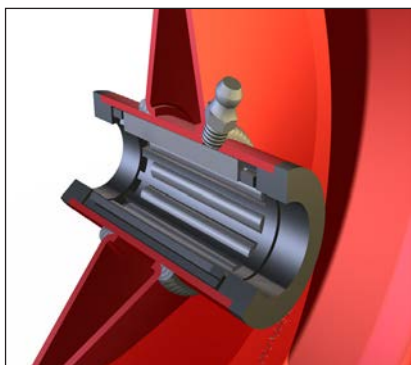

F

Supplied without bearings



G

No hub



R.I.S CONCEPT (RIM INSIDE SYSTEM)

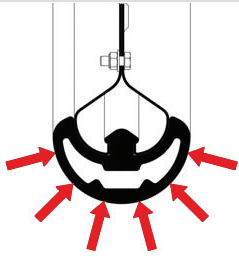

SELF CLEAN EFFECT ON 180°, no matter the weight load
NO INTERNAL PRESSURE (not inflated) so no risk of flat tire

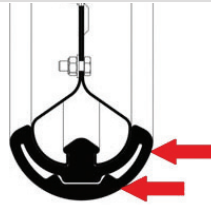

HIGH SIDE LOAD ALLOWED !
 Inner rim concept allows for excellent tire guidance.
 Tire locked into the rims.



"CONSTANT WHEEL RADIUS WHATEVER THE VERTICAL LOAD OR WEIGHT"

“UNIQUE CONCEPT - OTICO PATENT



DESIGNED FOR INTENSIVE USES

- **The tire CANNOT come off the rim** ▶
 Excels in steep/rough terrain
- Enables the use of flexible, **self-cleaning** tires



R.I.S System



Standard

See the full R.I.S. Concept tire range p. 26-27

CHOICE OF PROFILES

PROFILE CATEGORIES AND AGRONOMIC FUNCTIONS

FUNCTION ↓	PROFILE →	"L" SMOOTH PROFILE	"LV" LIP PROFILE	"LO" OBLIQUE PROFILE	"LB" HUMP PROFILE	"C" CLEATS PROFILE	"LF" FLAT PROFILE	"LC" CONCAVE PROFILE
Packing		✓	-	✓	✓	✓	✓	✓
Furrow closing		✓	-	✓	✓	✓	✓	-
Gauge		✓	✓	✓	✓	✓	✓	✓
Cleaning of the sowing discs"		-	✓	-	-	-	-	-
Intermediate press wheels		✓	-	-	-	-	-	-
Page number		p. 13 - 17	p. 22 - 23	p. 19	p. 18	p. 21	p. 24	p. 20

5 RUBBER FORMULATION DEVELOPED BY OTICO

FARMFLEX® tires are available with these various rubber formulations: 43s, 50s, 63s, 71s, 72s. Each one is adapted for a specific use (soil, climate, presence of residue, type of machine, etc.)

OTICO formulations

	43S	50S	63S STANDARD	71S	72S PREMIUM
Flexibility (self-cleaning)	++++	+++	++	+	+
Abrasion/ tear-resistant	+	++	++	+++	++++
Recommended use	Sticky soil	←—————→			Abrasive soil

DEFINITIONS OF PROFILES DESIGNATIONS

SMOOTH PROFILES

L	L	Smooth profile
	LR	Reinforced smooth
	LSR	Super-reinforced smooth
	LX	With steel reinforcement
	LRX	Reinforced smooth with steel reinforcement
	R.I.S L	Smooth concept R.I.S system

OBLIQUE PROFILES

LO	LO	Smooth, conical
	LOC	Smooth, conical, notched
	LOF	Smooth, conical, flat
	LOX	Smooth, conical with steel reinforcement
	R.I.S LO	Smooth, bevelled, R.I.S system

FLAT PROFILES

LF	LF	Flat
-----------	----	------

CONCAVE PROFILES

LC	LC	Smooth concave
	LCF	Flat and concave

LIP PROFILES

LV	LV	With a lip
	LVM	Steel lip
	LVR	Reinforced lip
	LVX	With a lip and steel reinforcement
	LRV	Reinforced lip
	R.I.S LV	Tire reinforced with a lip with R.I.S concept

CLEATS PROFILES

C	C	With cleats
	CR	Reinforced tire with cleats
	CRX	Reinforced tire with steel & cleats
	CS	Convex with cleats
	CSR	Reinforced convex tire with cleats
	CV	Concave tire with cleats and steel reinforcement
	CVX	Reinforced concave tire with cleats
	CX	Reinforced tire with steel

HUMP PROFILES

LB	LB	Smooth with a hump
	LRB	Smooth reinforced with a hump
	R.I.S LB	Ridge shaped R.I.S system

FARMFLEX® RANGE

SMOOTH PROFILE



Tire				Complete wheel				
	Dimensions Ø x width (mm)	Hardness	Tire ref.	Wheel type	Hub type	Hub dimensions	Bearing	Complete wheel ref.
	160x70 L	63 S	005177.00	-	-	-	-	-
	186x22 L	71 S	019033.00	MB	C2	16x44	KOYO®	019037.03
				MB	A	16x19.3	PEER®	020526.03
	195x26 L	50 S	020705.00	MB	C2	16x44	KOYO®	020706.03
				MB	A	16x19.3	PEER®	022121.03
	200x67 L	63 S	005188.00	PB	A	20x73	RLT	005193.03
				PB	A-N	20x73	NSK®	012495.03
				PB	F	16.2x73	-	005194.03
	218x22 L	71 S	019034.00	MB	C2	16x44	KOYO®	019038.03
				MB	A	16x19.3	PEER®	022117.03
	230x25 L	50 S	020688.00	MB	C2	16x44	KOYO®	020689.03
				MB	A	16x19.3	PEER®	022122.03
	230x80 L	63 S	004163.00	MM	A	20x70	RLT	005202.04
				MM	A	20x80	RLT	005203.04
				PB	A	20x70	NSK®	012966.03
				PB	A	20x70	RLT	008502.03
				PB	C1	16x26	PEER®	018717.03
				PB	C2	16x44	RLT	008504.03
	250x25 L	63 S	005230.00	PB	A	20x12	RLT	005233.03
	250x25 L	63 S	021024.00	MB	C2	16x44	KOYO®	022110.03
				MB	A	16x19.3	PEER®	022123.03
	250x27 L	63 S	021005.00	MB	C2	16x44	KOYO®	022111.03
				MB	A	16x19.3	PEER®	022123.03









SMOOTH PROFILE



Tire

Complete wheel



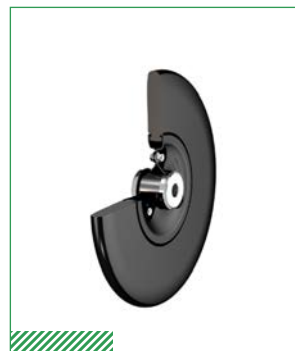
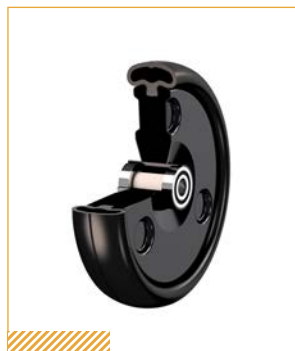

	Dimensions Ø x width (mm)	Hardness	Tire ref.	Wheel type	Hub type	Hub dimensions	Bearing	Complete wheel ref.
	250x42 L	43 S	010347.00	PB	A	10x44.5	RLT	005243.03
				PB	A	10x48	RLT	010205.03
		63 S	010346.00	PB	A	10x44.5	NSK-DDU®	012013.03
				PB	A	10x44.5	RLT	005241.03
				PB	A	10x49	RLT	005240.03
				PB	A	12x44.5	NSK®	008673.03
	250x80 L	50 S	020675.00	PB	A	20x70	RLT	020676.03
	265x100 L	60 S	005246.00	-	-	-	-	-
	268x22 L	71 S	019035.00	MB	C2	16x44	KOYO®	019039.03
				MB	A	16x19.3	PEER®	022118.03
		77 S	021651.00	MB	C2	16x44	KOYO®	021652.03
				MB	A	16x19.3	PEER®	022119.03
	280x60 LF	50 S	005079.00	MM	D	20x38	RLT	009017.04
	280x65 L	63 S	005247.00	MB	G	4-50-90	-	005262.04
				MM	A	20x70	RLT	011542.03
				MM	B	20.3x80	-	005251.04
				MM	D	-	-	008455.06
				MM	D	20x38	RLT	005256.04
	300x22	71 S	019036.00	MB	C2	16x44	KOYO®	019040.03
				MB	A	16x19.3	PEER®	022120.03
	300x28	50 S - 70 S	018542.00	MB	C2	16x44	KOYO®	019125.03
				MB	A	16x19.3	PEER®	022125.03





Tire

Complete wheel

	Dimensions Ø x width (mm)	Hardness	Tire ref.	Wheel type	Hub type	Hub dimensions	Bearing	Complete wheel ref.	
	300x100 L	60 S	005298.00	PB	A	20x90	RLT	010179.03	
				MM	A	20x90	RLT	005307.04	
				MM	D	20-25x55.1	RLT	016098.04	
				MM	D	20x38	NSK®	015812.04	
				MM	D	-	-	009581.06	
				MM	D	20x38	RLT	005304.04	
				MM	E	20x75	RLT	005301.04	
				PB	A	20x90	NSK®	014074.03	
				PB	A	20x90	RLT	008350.03	
				PB	C2	16x44	KOYO®	009359.03	
	310x25 L	60 S	005330.00	PB	C2	16x44	KOYO®	017640.03	
				MB	C2	16x44	KOYO®	009913.03	
				MB	C2	16x44	PEER®	009985.03	
				PB	C1	16x27	RLT	012855.03	
				PB	C2	16x44	KOYO®	008654.03	
				PB	C2	16x44	PEER®	012683.03	
				PB	C2	16x44	RLT	009280.03	
				PB	C2	16x72	PEER®	017782.03	
				005331.00 *	PB	C2	16x44	KOYO®	008532.03*
					318x50 L	63 S	005354.00	MB	C1
005355.00*	PB	C2	16x44				KOYO®	005360.03*	
	324x50 L	43 S	009395.00*	PB	C2	16x44	KOYO®	009396.22*	
			018718.00	-	-	-	-	-	



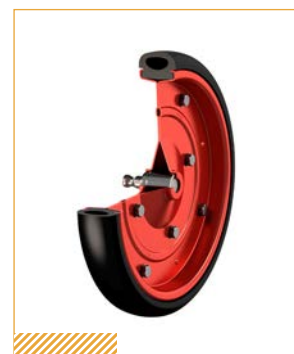

customer exclusivity*





Tire

Complete wheel















	Dimensions Ø x width (mm)	Hardness	Tire ref.	Wheel type	Hub type	Hub dimensions	Bearing	Complete wheel ref.
	325x50 L	63 S	005368.00	PB	C2	16x44	KOYO®	011417.03
				PB	C2	16x44	PEER®	013422.03
				PB	C2	16x72	PEER®	017784.03
		71 S	014100.00	PB	C2	16x44	PEER®	014101.03
				PB	C2	16x72	PEER®	017783.03
							PB	C2
	330x50 LR	43 S	008118.00	PB	C2	16x44	PEER®	012539.03
				PB	C2	16x44	PEER®	014579.03
				PB	C2	16x44	RLT	005382.03
		50 S	005374.00	MB	C2	16x44	KOYO®	008932.03
				MB	C2	16x44	PEER®	013857.03
				PB	C1	16x26	PEER®	020198.03
63 S	005375.00	PB	C2	16x44	KOYO®	005381.03		
		PB	C2	16x44	PEER®	010414.03		
		PB	C2	16x44	RLT	005380.03		
					MB	C2	16x44	PEER®
	330x50 LSR	50 S	010355.00	MB	C2	16x44	KOYO®	010356.03
		71 S	019848.00	PB	C2	16x44	KOYO®	021855.03
	330x65 LR	63 S	005384.00	MBE	C2	16x44	PEER®	013691.03
				PB	C1	16x26	PEER®	017751.03
				PB	C1	16x26	RLT	005389.03
				PB	C2	16x44	KOYO®	005390.03
				PB	C2	16x44	KOYO®	009281.03
				PB	C2	16x44	PEER®	012932.03
	335x65 LR	71 S	019992.00	PB	C2	16x44	PEER®	012989.03
		71 S	020463.00	MB	C2	16x44	PEER®	019993.03
								020464.03





Tire

Complete wheel

	Dimensions Ø x width (mm)	Hardness	Tire ref.	Wheel type	Hub type	Hub dimensions	Bearing	Complete wheel ref.
	330x75 LR	43 S	009533.00	PB	C2	16x44	RLT	009534.03
				MBE	C2	16x44	KOYO®	009969.03
		63 S	005396.00	MBE	C2	16x44	RLT	010007.03
				PB	C1	16x25	PEER®	020197.03
				PB	C2	16x44	KOYO®	015729.03
				PB	C2	16x44	PEER®	012663.03
	340x50 L	43 S	010428.00	PBB	C2	16x44	PEER®	013762.03
				PBB	C2		RLT	010399.03
				PBB	D	17x28	NSK®	010763.03
				PBB	D		SKF®	018929.03
		63 S	010395.00	-	-	-	-	-
	340x50 LR	63 S	014474.00	PB	C1	16x26	INA®	014476.05*
				PBB	D	17x28	NSF	018219.03
				PBB	D	17x28	SKF®	018930.03
	340x65 L	63 S	016177.00	PBB	C2	16x44	PEER®	016321.03
	350x33 LX	60 S	009928.00	MB	C2	16x44	PEER®	011351.03
	350x75 L	43 S	012372.00	PBB	C2	16x44	PEER®	016374.03
	350x75 LR	63 S	014548.00	PB	C1	16x26	INA®	014549.05*
	350x90 L	71 S	019804.00	MB	C2	20x44	PEER®	019812.03
	350x120 L	71 S	013853.00	PB	C2	16x44	OREFI®	013854.03*
	355x32 L	71 S	014232.00	PB	C2	17x44	PEER®	014236.03
	360x120 L	71 S	016902.00	MBB	C2	16x44	KOYO®	016903.03
				MM	A	20x60	RLT	005432.04
	360x33 L	63 S	005427.00	MM	A	25x56	NSK®	005431.07
	360x33 LR	71 S	005433.00	MM	A	20x60	RLT	009070.04
				MM	A	25x56	NSK®	010209.07

customer exclusivity*





Tire

Complete wheel

	Dimensions Ø x width (mm)	Hardness	Tire ref.	Wheel type	Hub type	Hub dimensions	Bearing	Complete wheel ref.
	360x50 L	63 S	005434.00	MB	C2	16x44	PEER®	012293.03
				MM	A	20x65	BEHAM®	013789.19
				MM	A	20x60	RLT	005438.06
				PB	A	20x60	RLT	005441.03
				PB	C2	16x44	PEER®	014683.03
	360x50 LR	63 S	005435.00	MM	A	20x60	RLT	005439.06
	380x50 L	50 S	014935.00	PB	C2	16x44	PEER®	014934.03
	380x65 L	50 S	005468.00	MM	A	20x60	BEHAM®	009644.19
				PBB	C2	16x44	PEER®	018392.03
			014922.00	PBB	C2	16x44	PEER®	012654.14*
				PB	A	20x60	FAG®	004502.03
				PB	A	20x65	BEHAM®	009642.03
	380x75 L	50 S	014963.00	PB	C2	16x44	PEER®	014964.03
		63 S	005473.00	MM	A	20x60	RLT	005475.06
	400x100 LR	71 S	005489.00	MB	C2	16x44	KOYO®	009360.03
				MB	C2	16x44	PEER®	014878.03
				MB	C2	16x44	RLT	005492.03
	400x116 RIS L	63 S	004446.00	MB	C1	16x30	RLT	004037.03
				MB	C2	16x44	RLT	004062.03
				MB	C2HD	16x44	KOYO®	013851.03
				MB	C2HD	16x44	PEER®	017989.03
				MB	G	4x10.8-120	-	019566.03
				MB	G	5x14.5-114.3	-	017680.03
				MB	G	3x13-97	-	021209.03
	405x100 L	71 S	007032.00*	-	-	-	-	
	410x60 L	71 S	011033.00	MM	A	30x55	RLT	011041.03
	410x80 L	71 S	005519.00	MM	A	30x55	RLT	011034.03
	415x90 RIS L	60 S	005516.00	MB	C2	16x44	RLT	005517.03
				MB	C2HD	16x44	KOYO®	013949.03
				MB	C2HD	16x44	PEER®	013950.03
	420x105 RIS L	71 S	015606.00	MBB	C2HD	16x44	KOYO®	015605.03
	425x140 RIS L	50 S	017454.00	MB	G	5-71.6-114.3	-	018260.03
	440x116 RIS L	50 S	017861.00	MB	C2	16x44	KOYO®	010768.03
				MB	G	3x13-97	-	017587.03
	450x80 L	71 S	005525.00	-	-	-	-	
	580x80 L	71 S	005570.00	PB	A	30x66	RLT	009921.03



Tire

Complete wheel



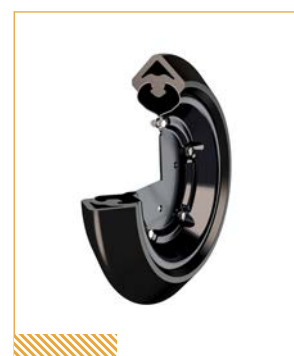





	Dimensions Ø x width (mm)	Hardness	Tire ref.	Wheel type	Hub type	Hub dimensions	Bearing	Complete wheel ref.
	280x65 LB	50 S	005263.00	MM	A	20x38	RLT	005265.04
				MM	B	20.3x80	-	005264.04
	330x75 LRB	63 S	010001.00	MBE	C2	16x44	PEER®	015695.03
				MBE	C2	16x44	RLT	014340.03
				PB	C1	16x26	PEER®	019042.03
		71 S	013782.00	PB	C2	16x44	PEER®	014456.03
				PB	C2	16x44	RLT	010002.03
				PB	C1	16x26	PEER®	019041.03
				PB	C2	16x44	PEER®	019031.03
	330x90 RIS LB	53 S	018364.00	PB	C2	16x44	PEER®	018365.03
	350x100 LB	50 S	018814.00	-	-	-	-	-
		60 S	008351.00	PB	C2	16x44	KOYO®	008953.03
	350x50 LB	72 S	015724.00	MB	C2	16x44	KOYO®	015725.03
	355x77 LRB	71 S	015022.00	PB	C2	16x44	PEER®	015023.03
	380x80 LB	71 S	017879.00	PB	C2	16x44	PEER®	017878.03
	380x80 LRB	72 S	022005.00	PB	C2	16x44	PEER®	022006.03
	420x100 RIS LB	63 S	007474.00	MB	C2HD	16x44	KOYO®	018596.03
				MB	G	3x13-97	-	017778.03
				MB	G	5x14.5-114.3	-	008962.03
	442x116 RIS LBA	50 S	019082.00	MB	G	5x14.5-114.3	-	019083.03
		71 S	018249.00	MB	G	5x14.5-114.3	-	018248.03





Tire

Complete wheel

	Dimensions Ø x width (mm)	Hardness	Tire ref.	Wheel type	Hub type	Hub dimensions	Bearing	Complete wheel ref.
	305x25 LO	63 S	010930.00	MB	C2	16x44	KOYO®	010929.03
	325x30 LO	63 S	005367.00	-	-	-	-	-
	350x50 LO	71 S	013698.00	MB	C2	16x44	KOYO®	013699.03
	380x57 LOX	63 S	005467.00 *	MB	C2	16x44	PEER®	012294.03*
	400x50 LOC	71 S	013902.00	MB	C2	16x44	KOYO®	014437.03
	410x75 LX	71 S	013714.00	MB	G	4x13-98	-	013715.03
	420x68 RIS LO	71 S	014685.00	MBB	C2HD	16x44	KOYO®	014686.03
	440x100 RIS LOF	71 S	015609.00	MBB	C2HD	16x44	KOYO®	015608.03

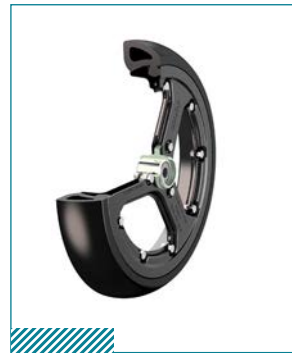
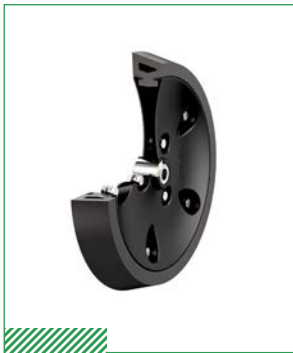





“

**PROVEN
QUALITY!**

















Tire				Complete wheel				
	Dimensions Ø x width (mm)	Hardness	Tire ref.	Wheel type	Hub type	Hub dimensions	Bearing	Complete wheel ref.
	290x80 LC	50 S	005273.00	-	-	-	-	-
	310x100 LCF	63 S	008353.00	PB	A	20x90	RLT	008997.03
				PB	C2	16x44	KOYO®	008954.03
		71 S	012515.00	PB	C2	16x44	PEER®	011367.03
	320x100 LC	43 S	008720.00	PB	A	20x90	RLT	008998.03
				PB	C2	16x44	RLT	008721.03
	330x108 LC	50 S	020743.00	-	-	-	-	-
		71 S	018408.00	PB	C2	16x44	KOYO®	018523.03
	330x85 LC	43 S	005401.00	-	-	-	-	-



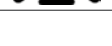

Tire

Complete wheel



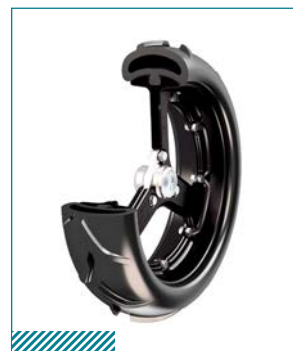











	Dimensions Ø x width (mm)	Hardness	Tire ref.	Wheel type	Hub type	Hub dimensions	Bearing	Complete wheel ref.		
	280x170 CS	50 S	021212.00	PB	A	20x170	RLT	021211.03		
MB				A	20x135	NSK®	016265.04			
MB				A	20x135	RLT	016264.04			
	370x165 CS	50 S	005443.00	MB	A	20x140	NSK®	016266.04		
				MB	A	20x180	NSK®	016267.04		
				MB	A	20x180	RLT	015893.04		
				PB	A	20x180	RLT	012206.03		
				PB	A	20x180	RLT	013486.03		
				63 S	013547.00	MB	A	20x149	BEHAM®	015871.04
				MB	A	20x149	BEHAM®	016261.04		
	370 x 165 CV	60 S	005460.00	MB	A	20x170	RLT	016260.04		
				MB	A	20x180	NSK®	016262.04		
				MB	A	20x180	RLT	015894.04		
				PB	A	20x180	NSK®	013816.03		
				PB	A	20x180	RLT	012205.03		
	370x165 CVX	60 S	005463.00	MB	A	20x140	NSK®	016263.04		
	430x120 RIS CS	53S	017681.00	MBB	A	20x44	NSK®	017682.03		
	430x145 RIS CS	53S	018262.00	MBBE	A	20x44	NSK®	020953.03		
	430x165 RIS CS	53S	018316.00	MBBE	A	20x75	NSK®	020954.03		
	500x175 C	60 S	005540.00	MB	A	20x135	RLT	005544.05		
				MB	A	20x135	RLT	005544.06		
				MB	A	20x184	RLT	005549.19		
	500x175 CR	63 S	005550.00	MB	A	20x135	RLT	011212.06		
				MB	A	20x184	RLT	005551.19		
	500x175 CX	63 S	005552.00	MB	A	20x184	RLT	005553.19		
	500x210 C	63 S	005555.00	MB	A	17x254	RLT	005561.03		
	570x175 CRX	50 S	012678.00	MB	A	20x135	NSK®	014805.05		





Tire







Complete wheel

	Dimensions Ø x width (mm)	Hardness	Tire ref.	Wheel type	Hub type	Hub dimensions	Bearing	Complete wheel ref.
	230x80 LV	63 S	005206.00	MM	A	20x70	RLT	010011.04
	305x68 RIS LV	63 S	011773.00	PB	C2	16x44	KOYO®	011778.03
	330x75 LRV	71 S	005394.00	MBE	C2	16x44	KOYO®	014556.03
				PB	C1	16x32	RLT	005395.03
				PB	C2	16x44	KOYO®	014555.03
	330x75 LSRV	71 S	016637.00	MBB	C2	16x44	KOYO®	016901.03
				MBE	C2	16x44	PEER®	013849.03
	350x100 LV	63 S	013850.00	PB	C2	16x44	PEER®	014588.03
		71 S	015669.00	MBE	C2	16x44	KOYO®	015693.03
	352x100 LV	71 S	018603.00	MBB	C2	16x44	KOYO®	018599.03
				MBB	C2	16x44	PEER®	021336.03
	400x55 LV	71 S	005081.00*	MB	G	6x8,5-110	-	005085.14*
			015885.00	MB	G	6x8,5-110	-	015886.03
	400x65 LV	60 S	005480.00	MB	C1	16x29	RLT	009239.03
				MB	C2	16x44	KOYO®	008961.03
				MB	C2	16x44	PEER®	011047.03
				MB	C2	16x44	RLT	009510.03
	400x67 LVX	63 S	011816.00	MB	C2	16x44	KOYO®	012556.03
				MB	C2	16x44	PEER®	012555.03
				MBB	C2HD	16x44	KOYO®	012526.03
				MBB	C2HD	16x44	PEER®	012525.03
		71 S	015354.00	MB	C2	16x44	KOYO®	019134.03
				MB	C1	16x30	RLT	005498.06
				MB	C1	16x30	RLT	005498.20
				MB	C2	16x44	KOYO®	009544.03
				MB	C2	16x44	RLT	005504.03
				MBB	C2HD	16x44	KOYO®	018789.03
		60 S	004528.00	MBB	C2HD	16x44	PEER®	018790.03
				MPB	C1	16x29	RLT	008588.03
				MPB	C2	16x44	KOYO®	005502.03
	400x115 LV			MPB	C2	16x44	PEER®	010412.03
				MPB	C2	16x44	RLT	005500.03
				M	G	6-247-271	-	010297.03
				MB	C2	16x44	PEER®	014557.03
				MB	C2	16x44	KOYO®	021866.03
				MBB	C2HD	16x44	KOYO®	012522.03
		71 S	011343.00	MBB	C2HD	16x44	PEER®	012523.03
				MPB	C2	16x44	KOYO®	011471.03
				MPB	C2	16x44	PEER®	011472.03
				M	G	6-247-271	-	011754.13
	400x115 LVR	72 S	021161.00	MB	C2	16x44	PEER®	021166.15



Tire

Complete wheel

	Dimensions Ø x width (mm)	Hardness	Tire ref.	Wheel type	Hub type	Hub dimensions	Bearing	Complete wheel ref.
	400x120 LV	63 S	012661.00	MBB	C2HD	16x44	KOYO®	017382.03
				MPB	C2	16x44	KOYO®	013353.03
				MPB	C2	16x44	PEER®	013362.03
		71 S	019724.00	MBB	C2HD	16x44	PEER®	019726.03
				MPB	C2	16x44	PEER®	015839.03
				MPB	C2	16x44	KOYO®	019903.03
	410x70 RIS LV	63 S	015841.00	MBB	C2HD	16x44	KOYO®	015840.03
				MBB	C2HD	16x44	PEER®	017358.03
		71 S	014599.00	MBB	C2HD	16x44	KOYO®	014601.03
				MBB	C2HD	16x44	PEER®	017357.03
	410x82 RIS LV	63 S	014108.00	MBB	C2HD	16x44	KOYO®	014109.03
		71 S	013560.00	MBB	C2HD	16x44	KOYO®	013771.03
	410x115 RIS LV	63 S	008632.00	MBB	C2HD	16x44	KOYO®	014156.03
				MBB	C2HD	16x44	PEER®	014107.03
		71 S	010021.00	MBB	C2HD	16x44	KOYO®	013780.03
				MBB	C2HD	16x44	PEER®	013855.03
	450x101 LV	72 S	021161.00*	MB	C2	16x44	PEER®	021166.03*
	420x120 RIS LV	71 S	019724.00	MBB	C2HD	16x44	PEER®	019726.03
	500x115 LV	63 S	005535.00*	MM	A	20x82	RLT	005539.07*



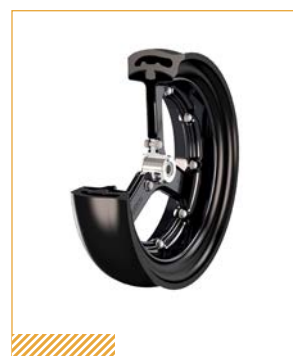
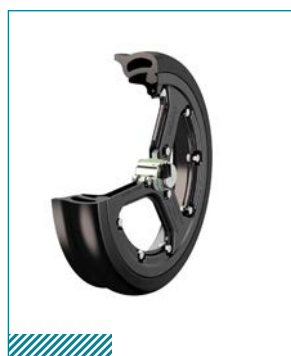
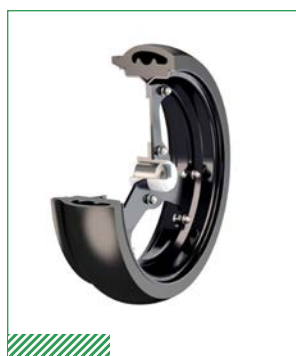

customer exclusivity*



**DYNAMIC TEST RIG
FOR QUICK PRODUCT
VALIDATION IN OUR
LABORATORY**





Tire				Complete wheel				
	Dimensions Ø x width (mm)	Hardness	Tire ref.	Wheel type	Hub type	Hub dimensions	Bearing	Complete wheel ref.
	248x23 LF	71 S	005207.00	-	-	-	-	-
	250x145 LF	63 S	005208.00	PB	A	20x130	NSK®	012672.03
				PB	A	20x130	RLT	009574.03
				PB	A	20x130	RLT	008712.16
				PB	F	22x132	-	009242.16
	250x170 LF	63 S	005217.00	PB	A	20x170	RLT	008711.03
				PB	A	20x188	RLT	009898.03
				PB	F	22x166	-	009241.16
	250x200 LF	63 S	005223.00	PB	A	20x200	RLT	008537.03



FOCUS : FIRMING WHEEL !



FOR A FAST AND EVEN CROP-RAISING!

Tire

Complete wheel

	Dimensions	Profile image	Hardness	Tire ref.	Self cleaning	Oblique mounting	Wheel concept	Hub concept	Hub dimensions	Bearing	Wheel Ref.
Solid tire → All-terrain reliability	186x22		71S	019033.00	+	Yes	MB	C2	16x44	KOYO®	019037.03
							MB	A	16x19.3	PEER®	020526.03
	218x22		71S	019034.00	+	Yes	MB	C2	16x44	KOYO®	019038.03
							MB	A	16x19.3	PEER®	022117.03
	268x22		71S	019035.00	++	Yes	MB	C2	16x44	KOYO®	019039.03
							MB	A	16x19.3	PEER®	022118.03
			77S	0216P51.00	+	Yes	MB	C2	16x44	KOYO®	021652.03
							MB	A	16x19.3	PEER®	022119.03
	300x22		71S	019036.00	++	Yes	MB	C2	16x44	KOYO®	019040.03
							MB	A	16x19.3	PEER®	022120.03
Hollow tire → Optimal self-cleaning	195x26		50S	020705.00	++++	No	MB	C2	16x44	KOYO®	020706.03
							MB	A	16x19.3	PEER®	022122.03
	230x25		50S	020688.00	+++	No	MB	C2	16x44	KOYO®	020689.03
							MB	A	16x19.3	PEER®	022122.03
	250x25		63S	021024.00	+++	No	MB	C2	16x44	KOYO®	022110.03
							MB	A	16x19.3	PEER®	022123.03
	250x27		63S	021005.00	+++	No	MB	C2	16x44	KOYO®	022111.03
							MB	A	16x19.3	PEER®	022124.03
	300x28		50S-71S	018542.00	+++	No	MB	C2	16x44	KOYO®	019125.03
							MB	A	16x19.3	PEER®	022125.03

2 TYPES OF HUBS



Hub C2 16x44

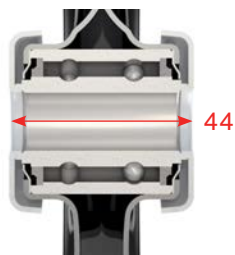

Performance

Hub A 16x19.3

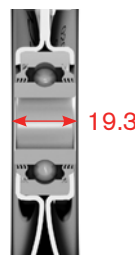

Reduced bulkiness



FOCUS : R.I.S WHEEL



Wheel	Wheel concept	PB	MB	MB	MB	MB
	Hub concept	C2	G	G	G	G
	Hub dimensions	16x44	-	-	-	-
	Nb. of holes		3	4	5	4-5-6
	Diameter holes position		97 mm	100&120 mm	114,3 mm	98 mm
	Load capacity		+	+++	+++	+++

Tires	Profile	Hardness	Dimensions							
			Ø	x width (mm)						
C		53S	430x120	RIS CS						
		53S	430x145	RIS CS						
		53S	430x165	RIS CS						
L		63S	400x116	RIS L		✓	✓		✓	✓
		63S	415x90	RIS L		✓	✓	✓	✓	✓
		71S	420x105	RIS L						
		50S	425x140	RIS L		✓	✓	✓	✓	✓
		50S	440x116	RIS L		✓	✓	✓	✓	✓
LB		50S	330x90	RIS LB	✓					
		63S	420x100	RIS LB		✓	✓	✓	✓	✓
		50S / 71S	442x116	RIS LBA		✓	✓	✓	✓	✓
LO		71S	420x68	RIS LO						
		71S	440x100	RIS LOF						
LV		63S	305x68	RIS LV	✓					
		63S / 71S	410x70	RIS LV						
		63S / 71S	410x82	RIS LV						
		63S / 71S	410x115	RIS LV						
		63S / 71S	420x120	RIS LV						





MB	MB	MB	MBHD	MBB	MBB	MBB	MBBE	MBBHD	MBBHD+
C2HD	C2	C2	C2	C2	C2HD	A	A	C2	C2
16x44	16x44	16x44	16x44	16x44	16x44	20x44		16x44	16x44
++	+	+	++	+	++	++	++	+++	++++
		✓	✓	✓	✓	✓		✓	✓
							✓		
							✓		
✓	✓								
✓	✓								
		✓	✓	✓	✓	✓		✓	✓
✓	✓								
✓	✓								
✓	✓								
		✓	✓	✓	✓	✓		✓	✓
		✓	✓	✓	✓	✓		✓	✓
		✓	✓	✓	✓	✓		✓	✓
		✓	✓	✓	✓	✓		✓	✓
		✓	✓	✓	✓	✓		✓	✓
		✓	✓	✓	✓	✓		✓	✓



410x115 RIS LV / MBB / C2HD

OPTIONS FOR FARMFLEX® WHEELS

CUP AND CAP FOR C2 & C2HD HUB

➤ Improves ball bearing **protection** thus **sealing** it from **dust and water during high-pressure washing**

➤ Option only available on some references

➤ Delivered unassembled

➤ Choice of:

- ▶ 1 or 2 cup per wheel
- ▶ 1 cap with circlip (C2HD hub only)



C2 hub
1 or 2 caps

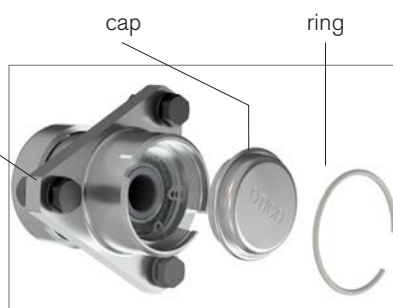

C2HD hub
1 cup + 1 cap



C2HD hub
1 cup + 1 cap

ACCESSORIES

➤ Dimensions (ø x w): **354x40**

➤ Bore : 16 mm

➤ **C2HD** hub by **OTICO**

➤ Ref. 020777.03

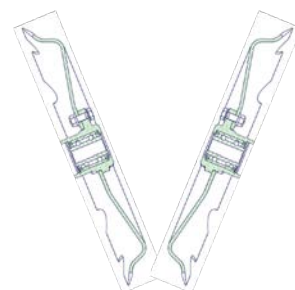

STEEL WHEELS - FOR AGGRESSIVE FURROW CLOSING WITH HARD / COMPACTED SOIL

TESTIMONIALS



Frédéric FABRE
La croix en Brie - France

“ I HAVE BEEN WORKING WITH MY CULTIVATOR SINCE 1998. DESPITE A VERY HIGH FLINT PROPORTION MY FARMFLEX WHEELS ARE STILL ORIGINAL AND NEVER GOT TORN !

I have a large variety of soils and even without wheel scrapers, soil does not stick. I am 100% satisfied !”

I'VE BEEN USING OTICO 420X100 LB WHEELS ON MY HORSCH SPRINTER NT FOR THE PAST 3 YEARS.

I'm very satisfied with these V-shaped wheels and the robustness of OTICO rubber. I used to use inflatable and semi-hollow products by another supplier but their tires ended up splitting too fast. I also own OTICO 440x116L wheels which excel in humid conditions thanks to their high flexibility.”



Dan COFFEY
Victoria – Australia

TESTIMONIALS



“ I’VE BEEN USING OTICO 400X120 LV SPOKE WHEELS FOR THE PAST 5 YEARS ON MY CUSTOM-BUILT DIRECT SEEDER WHICH I MADE MYSELF.

I am raving about them especially for their reliability. What’s more, the RID profile leaves the soil breathing around the furrow which greatly improves its consolidation. Crop-raising is always a success.”



Jean-Claude QUILLET
Montluis sur Loire - France

“

WE USE OTICO FARMFLEX WHEELS 380X80 LB ON OUR EQUALIZER SEEDER SINCE 2016.

We have very abrasive and dry soils, the FARMFLEX conical shape and the flat shape of the rim are perfect to consolidate and define the furrow in every conditions.

We improve seeding agronomy thanks to this new FARMFLEX wheel !”



Daniel ROSSOUW
South Africa





20 Rue Gabriel Garnier
77650 Chalmaison, FRANCE
☎ +33 (0)1 64 08 60 75
info@otico.fr

www.otico.com



Follow us on Twitter

 **OTICO**[®]